

Product Card

Cover frame, Impressivo, 85mm, 5-gang, white



Cover frame

Cover frame, Impressivo, 85mm, 5-gang, white

Type: 1725F85-84

Product ID: 2TKA000434G1

GTIN: 6418677327933



Flush mounting cover frame for 1-gang cover plated accessories, such as switches. Suitable for both horizontal and vertical installation. The manufacture material is a durable high quality plastic. The surface is glossy and easy to keep clean. Cleaning with a mild, standard household detergent. Be careful when cleaning with a powerful dissolvent.

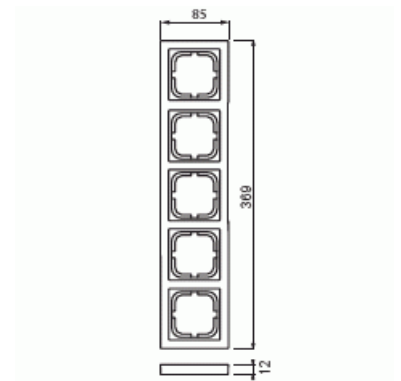

Technical specification

Classification

Enclosure class:	IP21
------------------	------

Packing

Package:	1/5/25/700
Unit:	PCS

ETIM Data

Number of units:	1
Mounting direction:	Horizontal and vertical
Number of units horizontal:	1
Number of units vertical:	1

Product Card

Cover frame, Impressivo, 85mm, 5-gang, white



With mounting grid:	No
Flush-mounted installation:	Yes
Suitable for floor box:	No
Suitable for wall duct:	Yes
Suitable for built-in installation:	No
Label space/information surface:	No
Material:	Plastic
Material quality:	Thermoplastic
Halogen free:	Yes
Anti-bacterial treatment:	No
Surface protection:	Untreated
Surface finishing:	Glossy
Colour:	White
RAL-number (similar):	9016
Transparent:	No
With hinged lid:	No
Degree of protection (IP):	IP21
Type of fastening:	Clamping/screw mounting
Width:	85 mm
Height:	12 mm
Depth:	369 mm
Built-in width:	369 mm
Built-in height:	85 mm
Diameter bore hole (opening):	74 mm