

## Product Card

Cover frame, Impressivo, 100mm, 3-gang, anthracite



# Cover frame

Cover frame, Impressivo, 100mm, 3-gang, anthracite

**Type:** 1723F100-81

**Product ID:** 2TKA000365G1

**GTIN:** 6418677328077



Flush mounting cover plate for 2-gang cover plated accessories, such as double socket outlets. Also 1-gang accessories, such as switches, can be mounted with the adaptor 2519-xx. Suitable for both horizontal and vertical installation. The manufacture material is a durable high quality plastic. The surface is glossy and easy to keep clean. Cleaning with a mild, standard household detergent. Be careful when cleaning with a powerful dissolvent.

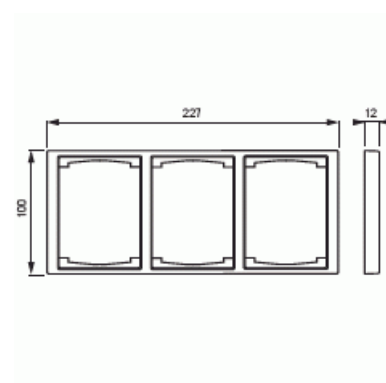

## Technical specification

### Packing

Package:	1/5/50/900
Unit:	PCS

### ETIM Data

Number of units:	1
Mounting direction:	Horizontal and vertical
Number of units horizontal:	1
Number of units vertical:	1
With mounting grid:	No
Flush-mounted installation:	Yes
Suitable for floor box:	No

# Product Card

Cover frame, Impressivo, 100mm, 3-gang, anthracite



Suitable for wall duct:	No
Suitable for built-in installation:	No
Label space/information surface:	No
Material:	Plastic
Material quality:	Thermoplastic
Halogen free:	Yes
Anti-bacterial treatment:	No
Surface protection:	Untreated
Surface finishing:	Glossy
Colour:	Anthracite
RAL-number (similar):	7021
Transparent:	No
With hinged lid:	No
Degree of protection (IP):	IP21
Type of fastening:	Clamping/screw mounting
Width:	100 mm
Height:	12 mm
Depth:	227 mm
Built-in width:	227 mm
Built-in height:	100 mm
Diameter bore hole (opening):	74 mm