

Product Card

Surface mounting frame, Impressivo, 100mm, h=40mm, 2-gang, anthracite



Surf. Mount. frame

Surface mounting frame, Impressivo, 100mm, h=40mm, 2-gang, anthracite

Type: 1722S100-81

Product ID: 2TKA000340G1

GTIN: 6418677331190



Impressivo flush mounting products are able to be surface mounted with surface mounting frames and surface mounting box (2456.26). Using center plates with lid the socket outlets are water protected (IP44). The switches and push switches are also water protected (IP44) when using screw mounted rocker frames (2474 or 2475). In the cases of the other products than socket outlets and switches the water protection depends on the water protection of the center plate. The manufacture material is a durable high quality plastic. The surface is glossy and easy to keep clean. Cleaning with a mild, standard household detergent. Be careful when cleaning with a powerful dissolvent.

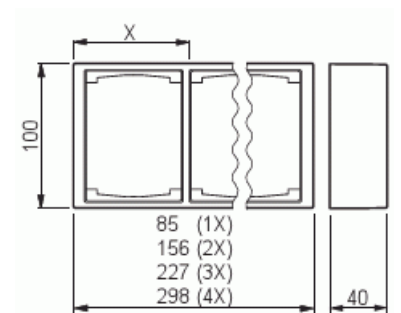

Technical specification

Packing

Package:	1/25
Unit:	PCS

ETIM Data

Assembly arrangement:	Surface mounted frame
Suitable for modular domestic switching devices:	No
Number of units:	2

Product Card

Surface mounting frame, Impressivo, 100mm, h=40mm, 2-gang, anthracite



Mounting direction:	Horizontal and vertical
Shape:	Rectangular
Material:	Plastic
Material quality:	Thermoplastic
Halogen free:	Yes
Surface protection:	Untreated
Surface finishing:	Glossy
Colour:	Anthracite
RAL-number (similar):	7021
Transparent:	No
With cover frame:	No
With duct entry:	No
With cable entry:	No
With screw gland entry:	No
Shock resistant:	No
Degree of protection (IP):	IP21
Width:	40 mm
Height:	100 mm
Depth:	156 mm
Device width:	40
Device height:	100
Device depth:	156