

Product Card

Cover frame, Impressivo, 100mm, 1-gang, white matt



Cover frame

Cover frame, Impressivo, 100mm, 1-gang, white matt

Type: 1721F100-884

Product ID: 2TKA00004806

GTIN: 6438199008998



Flush mounting cover plate for 2-gang cover plated accessories, such as double socket outlets. Also 1-gang accessories, such as switches, can be mounted with the adaptor 2519-xx. Suitable for both horizontal and vertical installation. The manufacture material is a durable high quality plastic. The surface is matt and easy to keep clean. Cleaning with a mild, standard household detergent. Be careful when cleaning with a powerful dissolvent.

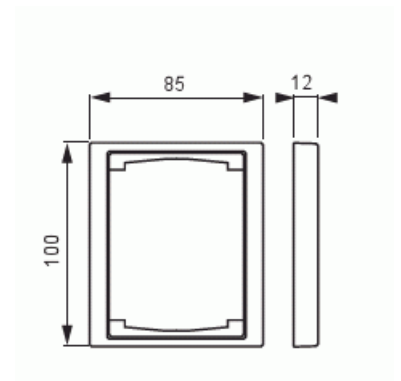

Technical specification

Packing

Package:	1/10/100/2800
Unit:	PCS

ETIM Data

Number of units:	1
Mounting direction:	Horizontal and vertical
Number of units horizontal:	1
Number of units vertical:	1
With mounting grid:	No
Flush-mounted installation:	Yes
Suitable for floor box:	No

Product Card

Cover frame, Impressivo, 100mm, 1-gang, white matt



Suitable for wall duct:	No
Suitable for built-in installation:	No
Label space/information surface:	No
Material:	Plastic
Material quality:	Thermoplastic
Halogen free:	Yes
Anti-bacterial treatment:	No
Surface protection:	Untreated
Surface finishing:	Matt
Colour:	White
RAL-number (similar):	9016
Transparent:	No
With hinged lid:	No
Degree of protection (IP):	IP21
Type of fastening:	Clamping/screw mounting
Width:	100 mm
Height:	12 mm
Depth:	100 mm