

Product Card

Ø16 mm, 90°, sleeve on the long end



Conduit bend, Halogen free (HF)

Ø16 mm, 90°, sleeve on the long end

Type: JMKL16.8HF

Product ID: 2TKA00004744

GTIN: 6438199000695



Halogen free (HF) 90° conduit bend. Sleeve on the long end.
Compression strength 750N.

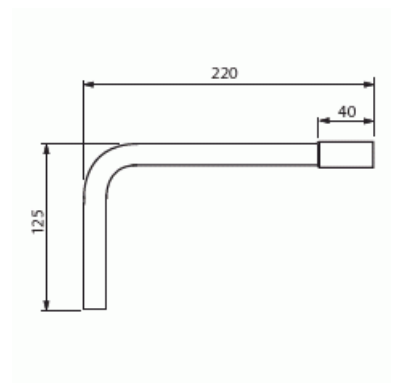

Technical specification

Packing

Package:	20/200
Unit:	PCS

ETIM Data

Surface polished:	Yes
Surface brushed:	No
Halogen free:	Yes
With sleeve:	Yes
Two piece:	No
With inspection opening and cover:	No
Flexible:	No

Product Card

Ø16 mm, 90°, sleeve on the long end



—
© ABB 2024

Business ID 0763403-0

www.installationmaterials.com

—
Customer service

puh. +358 10 222 1999

contact.center@fi.abb.com

—
ABB Exchange

+358 10 22 11