

## Product Card

Cover frame, Impressivo, 100mm, 2-gang, black matt



# Cover frame

Cover frame, Impressivo, 100mm, 2-gang, black matt

**Type:** 1722F100-885

**Product ID:** 2TKA00004079

**GTIN:** 6438199006048



Flush mounting cover plate for 2-gang cover plated accessories, such as double socket outlets. Also 1-gang accessories, such as switches, can be mounted with the adaptor 2519-xx. Suitable for both horizontal and vertical installation. The manufacture material is a durable high quality plastic. The surface is matt and easy to keep clean. Cleaning with a mild, standard household detergent. Be careful when cleaning with a powerful dissolvent.

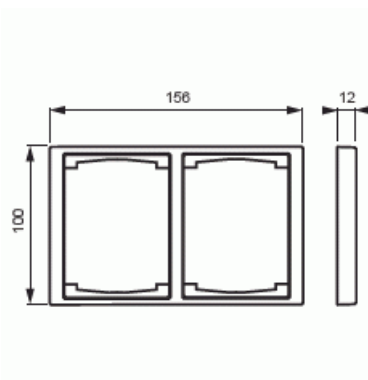

## Technical specification

### Packing

Package:	1/5/50/1400
Unit:	PCS

### ETIM Data

Number of units:	2
Mounting direction:	Horizontal and vertical
Number of units horizontal:	1
Number of units vertical:	1
With mounting grid:	No
Suitable for floor box:	No
Suitable for wall duct:	No

# Product Card

Cover frame, Impressivo, 100mm, 2-gang, black matt



Suitable for built-in installation:	No
Label space/information surface:	No
Material:	Plastic
Material quality:	Thermoplastic
Halogen free:	Yes
Surface protection:	Lacquered
Surface finishing:	Matt
Colour:	Black
RAL-number (similar):	9005
Transparent:	No
With hinged lid:	No
Degree of protection (IP):	IP21
Type of fastening:	Clamping/screw mounting
Width:	100 mm
Height:	12 mm
Depth:	100 mm
Built-in width:	156 mm
Built-in height:	100 mm