

Product Card

Cover frame, 80mm, 4-gang, white matt



Cover frame

Cover frame, 80mm, 4-gang, white matt

Type: 1724-884K

Product ID: 2CKA001754A4417

GTIN: 4011395128275



Flush mounting cover frame for 1-gang accessories, such as switches. The surface is painted. Cleaning with a mild, standard household detergent. Be careful when cleaning with a powerful dissolvent.

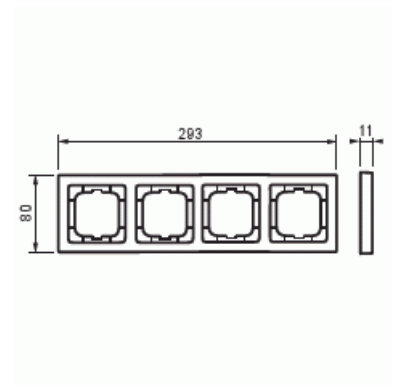

Technical specification

Packing

Package:	1
Unit:	PCS

ETIM Data

ETIM Version:	ETIM-9.0
ETIM Class:	EC000007
Number of units:	4
Mounting direction:	Horizontal and vertical
Number of units horizontal:	4
Number of units vertical:	4
With mounting grid:	No

Product Card

Cover frame, 80mm, 4-gang, white matt



Flush-mounted installation:	Yes
Suitable for floor box:	No
Suitable for wall duct:	Yes
Suitable for built-in installation:	No
Label space/information surface:	No
Material:	Plastic
Material quality:	Thermoplastic
Halogen free:	Yes
Anti-bacterial treatment:	No
Surface protection:	Lacquered
Surface finishing:	Matt
Colour:	White
RAL-number (similar):	9016
Transparent:	No
With hinged lid:	No
Degree of protection (IP):	IP20
Impact strength:	IK03
Type of fastening:	Clamp mounting
Width:	80 mm
Height:	293 mm
Depth:	11 mm
Built-in width:	63 mm
Built-in height:	63 mm
Diameter bore hole (opening):	71 mm