

## Product Card

Cover frame, 80mm, 3-gang, white matt



# Cover frame

Cover frame, 80mm, 3-gang, white matt

**Type:** 1723-884K

**Product ID:** 2CKA001754A4416

**GTIN:** 4011395128268



Flush mounting cover frame for 1-gang accessories, such as switches. The surface is painted. Cleaning with a mild, standard household detergent. Be careful when cleaning with a powerful dissolvent.

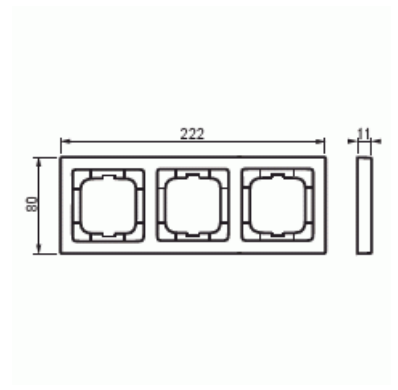

## Technical specification

### Packing

Package:	1
Unit:	PCS

### ETIM Data

ETIM Version:	ETIM-9.0
ETIM Class:	EC000007
Number of units:	3
Mounting direction:	Horizontal and vertical
Number of units horizontal:	3
Number of units vertical:	3
With mounting grid:	No

# Product Card

Cover frame, 80mm, 3-gang, white matt



Flush-mounted installation:	Yes
Suitable for floor box:	No
Suitable for wall duct:	Yes
Suitable for built-in installation:	No
Label space/information surface:	No
Material:	Plastic
Material quality:	Thermoplastic
Halogen free:	Yes
Anti-bacterial treatment:	No
Surface protection:	Lacquered
Surface finishing:	Matt
Colour:	White
RAL-number (similar):	9016
Transparent:	No
With hinged lid:	No
Degree of protection (IP):	IP20
Impact strength:	IK03
Type of fastening:	Clamp mounting
Width:	80 mm
Height:	222 mm
Depth:	11 mm
Built-in width:	63 mm
Built-in height:	63 mm
Diameter bore hole (opening):	71 mm