

Product Card

Cover frame, Carat, 4-gang, Black



Cover frame

Cover frame, Carat, 4-gang, Black

Type: 1724-825

Product ID: 2CKA001754A4325

GTIN: 4011395088944



Flush mounting cover frame for 1-gang cover plated accessories, such as switches. Material glass. Cleaning with a mild, standard household detergent. The use of strong dissolvents should be avoided.

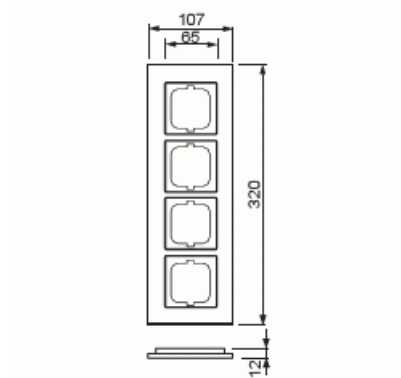

Technical specification

Classification

Enclosure class:	IP20
------------------	------

Colors

Colour:	Black
---------	-------

Packing

Package:	1
Unit:	PCS

ETIM Data

ETIM Version:	ETIM-9.0
---------------	----------

Product Card

Cover frame, Carat, 4-gang, Black



ETIM Class:	EC000007
Number of units:	4
Mounting direction:	Horizontal and vertical
Number of units horizontal:	4
Number of units vertical:	4
With mounting grid:	No
Flush-mounted installation:	Yes
Suitable for floor box:	No
Suitable for wall duct:	Yes
Suitable for built-in installation:	No
Label space/information surface:	No
Material:	Glass
Material quality:	Glass
Halogen free:	Yes
Anti-bacterial treatment:	No
Surface protection:	Untreated
Surface finishing:	Glossy
Colour:	Black
Transparent:	No
With hinged lid:	No
Degree of protection (IP):	IP20
Impact strength:	IK03
Type of fastening:	Clamp mounting
Width:	107 mm
Height:	320 mm
Depth:	11 mm
Built-in width:	63 mm
Built-in height:	63 mm
Diameter bore hole (opening):	71 mm