

Product Card

Cover frame, 80mm, 3-gang, steel



Cover frame

Cover frame, 80mm, 3-gang, steel

Type: 1723-866K

Product ID: 2CKA001754A4319

GTIN: 4011395088371



Flush mounting cover frame for 1-gang accessories, such as switches. The surface is pure stainless steel and easy to keep clean. Cleaning with a mild, standard household detergent. Be careful when cleaning with a powerful dissolvent.

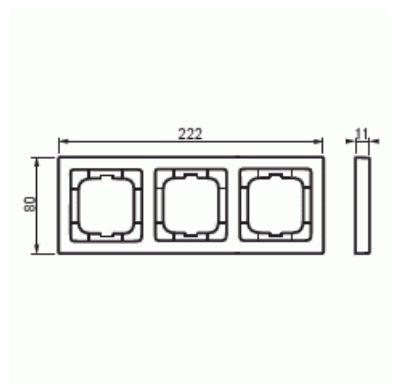

Technical specification

Classification

Enclosure class:	IP20
------------------	------

Packing

Package:	1/10/100/900
Unit:	PCS

ETIM Data

Number of units:	3
Mounting direction:	Horizontal and vertical
Number of units horizontal:	3
Number of units vertical:	3

Product Card

Cover frame, 80mm, 3-gang, steel



With mounting grid:	No
Flush-mounted installation:	Yes
Suitable for floor box:	No
Suitable for wall duct:	Yes
Suitable for built-in installation:	No
Label space/information surface:	No
Material:	Metal
Material quality:	Stainless steel
Halogen free:	Yes
Anti-bacterial treatment:	No
Surface protection:	Untreated
Surface finishing:	Matt
Colour:	Stainless steel
Transparent:	No
With hinged lid:	No
Degree of protection (IP):	IP20
Impact strength:	IK03
Type of fastening:	Clamp mounting
Width:	80 mm
Height:	222 mm
Depth:	11 mm
Built-in width:	63 mm
Built-in height:	63 mm
Diameter bore hole (opening):	71 mm