

ABB-Welcome

M25102xC

M25102xA-x-

M25102xPx.

M25102xK-x.

M25102xCR.

5102xDN

5101xPx

Outdoor station



Module family



Camera module



Audio module



Audio module
1/2 button



Audio module
2/4 button



Nameplate module



Round pushbutton
1 button



Round pushbutton
2 button



Round pushbutton
3 button



Pushbutton
3/6 button



Pushbutton
4/8 button



Round pushbutton
1 button, with NFC/IC



Round pushbutton
2 button, with
NFC/IC



Round pushbutton
3 button, with
NFC/IC



Keypad (3 versions)
Stainless steel
Aluminum
White



Display with ID
Display with IC

ABB-Welcome

| | | |
|-------|--|-------------------------------------|
| 1 | Safety | 5 |
| 2 | Intended use..... | 5 |
| 3 | Environment | 5 |
| 3.1 | ABB devices | 5 |
| 4 | Terminal description | 7 |
| 4.1 | Audio module..... | 7 |
| 4.1.1 | Lock connected with terminals 3 and 4..... | Error! Bookmark not defined. |
| 4.2 | Camera module | 14 |
| 4.2.1 | Analog camera connected with terminal 1 | 15 |
| 4.2.2 | Detached camera connection | 16 |
| 4.3 | Round pushbutton module..... | 17 |
| 4.4 | Pushbutton module..... | 19 |
| 4.5 | Keypad module..... | 21 |
| 4.6 | Display and card reader module | 23 |
| 4.7 | Nameplate module | 25 |
| 5 | Operation..... | 27 |
| 5.1 | Pushbutton outdoor station..... | 27 |
| 5.1.1 | Addressing..... | 27 |
| 5.1.2 | Setting the language for the voice messages (if the audio module has a speech synthesis function)..... | 31 |
| 5.2 | Pushbutton outdoor station with display module..... | 34 |
| 5.3 | Pushbutton outdoor station with keypad module | 36 |
| 5.4 | Round pushbutton outdoor station with IC/NFC | 38 |
| 5.5 | Keypad outdoor station..... | 42 |
| 5.5.1 | Call a resident (3 types)..... | 42 |
| 5.5.2 | Call the guard unit | 44 |
| 5.5.3 | If an indoor station is in "leave home mode" | 44 |
| 5.5.4 | If a guard unit is in "intercept mode" | 45 |
| 5.5.5 | System settings | 46 |
| 5.6 | Keypad outdoor station without display (camera + audio + keypad)..... | 56 |
| 5.6.1 | Calling a resident by inputting physical address | 56 |
| 5.6.2 | Call guard unit | 56 |
| 5.6.3 | System settings | 56 |
| 6 | Advanced configuration | 58 |
| 7 | Technical data | 59 |

| | | |
|-----|--|----|
| 8 | Mounting/installation..... | 60 |
| 8.1 | Requirements for the electrician | 60 |
| 8.2 | General installation instructions..... | 62 |
| 8.3 | Mounting..... | 63 |

1 Safety



Warning

Electric voltage!

Dangerous currents flow through the body when coming into direct or indirect contact with live components.

This can result in electric shock, burns or even death.

- Disconnect the mains power supply prior to installation and/or disassembly!
- Permit work on the 110-240 V supply system to be performed only by specialist staff!

2 Intended use

The outdoor station is an integral part of the ABB-Welcome door entry system and operates exclusively with components from this system. The device must only be used with suitable ABB flush-mounted installation sockets and rain hood.

3 Environment



Consider the protection of the environment!

Used electric and electronic devices must not be disposed of with household waste.

- The device contains valuable raw materials that can be recycled. Therefore, dispose of the device at the appropriate collecting facility.

3.1 ABB devices

All packaging materials and devices from ABB bear the markings and test seals for proper disposal. Always dispose of the packing materials and electric devices and their components via an authorized collection facility or disposal company.

ABB products meet the legal requirements, in particular the laws governing electronic and electrical devices and the REACH ordinance.

(EU-Directive 2002/96/EG WEEE and 2002/95/EG RoHS)

(EU-REACH ordinance and law for the implementation of the ordinance (EG)

No.1907/2006)

4 Terminal description

4.1 Audio module

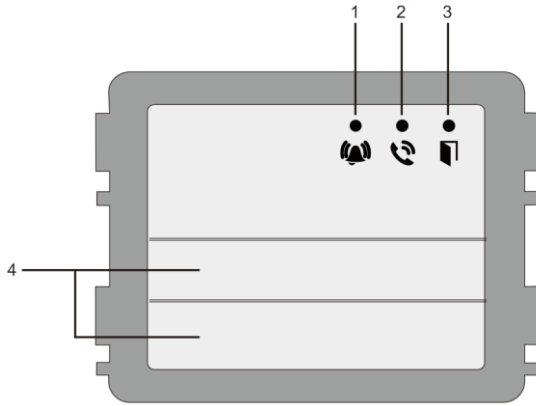

| No. | Function |
|-----|--|
| 1 | LED flashes slowly, indicating a call has been established LED flashes fast, indicating that the system is busy |
| 2 | LED illuminates, indicating possible communication |
| 3 | LED illuminates, indicating the door is unlocked |
| 4 | Call pushbuttons |

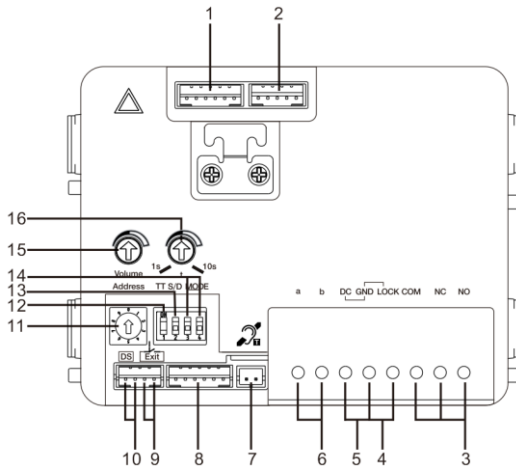

| No. | Functions |
|-----|---|
| 1 | Connector for camera module |
| 2 | Connector for device software update |
| 3 | Plug-in clamps (COM-NC-NO) for floating output, door opener (30VAC/DC 1A) |
| 4 | Plug-in clamps (Lock-GND) for door opener (18V 4A impulsive, 250 mA holding) |
| 5 | Plug-in clamps (DC-GND) for additional power supply |
| 6 | Plug-in clamps (a-b) for bus connection |
| 7 | Connector for induction loop module |
| 8 | Connector for next module |
| 9 | Connector for exit pushbutton |
| 10 | Connector for sensor for checking the door status |
| 11 | Rotary switch for setting the address of OS (1-9) |
| 12 | Set feedback tones for pushbuttons and for outdoor station when making a call: ON/OFF |
| 13 | Configure pushbuttons in a single column or double column mode (ON=double column; OFF=single column) It only affects the bar pushbutton, not the round pushbutton. |
| 14 | Configure functions of the 1st/2nd pushbuttons. 3->OFF, 4->OFF=call indoor station/call indoor station 3->ON, 4->OFF=switch on lighting/call indoor station |

| | |
|----|--|
| | 3->OFF, 4->ON=call guard unit/call indoor station 3->ON, 4->ON=switch on lighting/call guard unit |
| 15 | Adjust the loudspeaker volume. |
| 16 | *Adjust the door lock release time, 1-10s (available for the lock connected with the default lock) |

*Default lock (1st lock): Released by "Unlock" button of the indoor station. Factory setting is LOCK-GND.

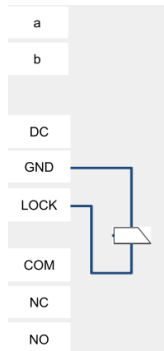
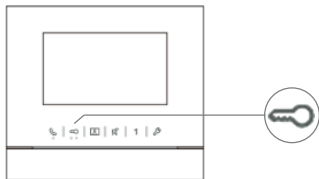

2nd lock: Released by programmable button "1" of the indoor station. Factory setting is COM-NO.

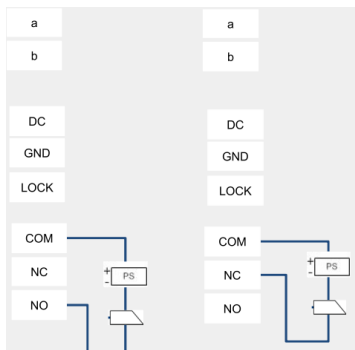
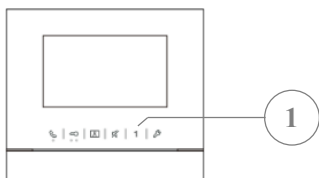

Change default lock

Default lock can be set at either "Lock-GND" or "NO-NC-COM"

1

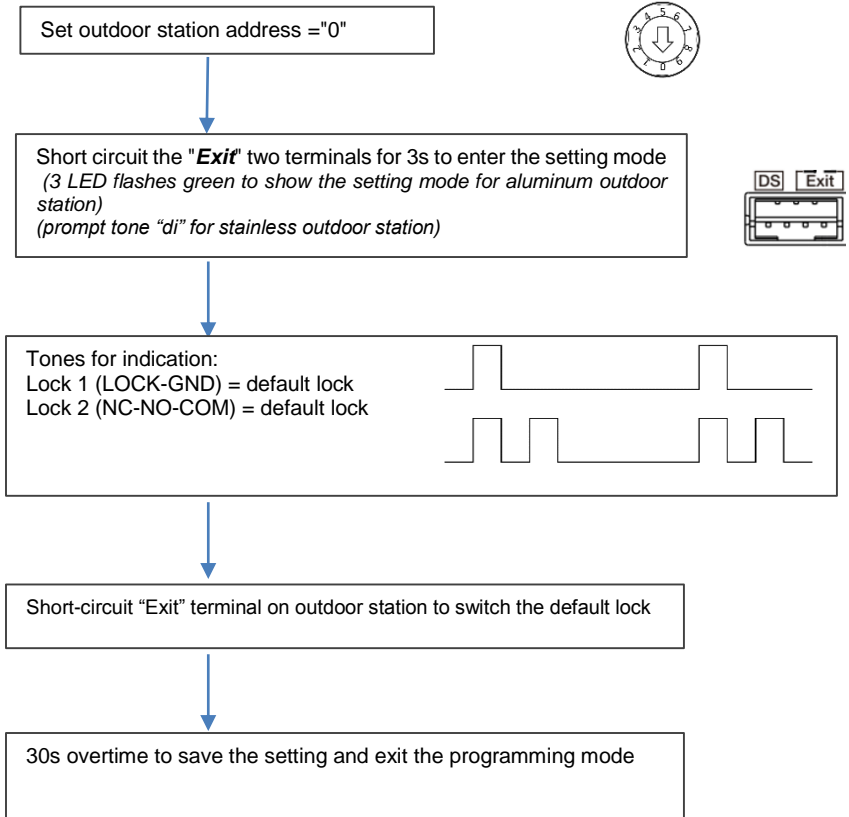

Set the lock time of the default lock

Set the time by the potentiometer, from 1-10s



Set the lock time of the 2nd lock

Set outdoor station address ="0"



Short circuit the "DS" two terminals for 3s to enter the setting mode
(3 LED flashes green to show the setting mode for aluminum outdoor station)
(Prompt tone "di" for stainless outdoor station)

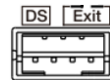

Record the time for 1st lock
Then set the time for 2nd-Lock from 1-10s







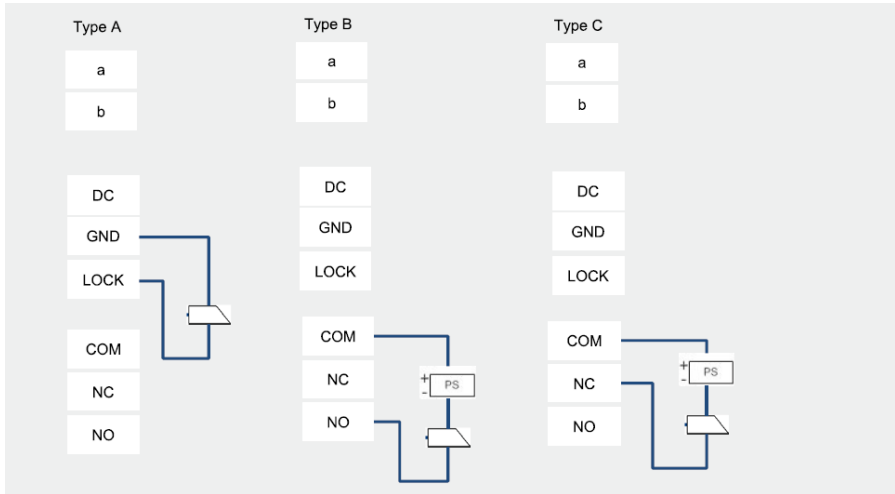

30s overtime to save the setting and exit the programming mode
At last set the time back for 1st-Lock

Recover the time to the original time for 1st lock



4.1.1 Lock connected with terminals 3 and 4



| Lock type | Pic | Operation type | Voltage | Wiring |
|---------------------------|---|-----------------------|-----------|------------------|
| Electric Strike Lock, 12V |  | Power supply to open. | 12V DC/AC | Type A Type B |
| Electric Strike Lock, 24V |  | Power supply to open. | 24V DC/AC | Type B |
| Electric Rim Lock, 12V |  | Power supply to open. | 12VDC | Type A Type B |
| Electric mortise lock |  | Power on to close. | 12VDC | Type C |
| Magnetic lock |  | Power on to close. | 12/24VDC | Type C |

4.2 Camera module

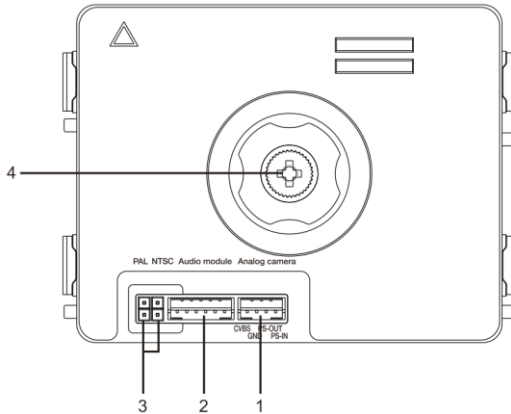

| No. | Functions |
|-----|---|
| 1 | Connector for additional analog camera |
| 2 | Connector for audio module |
| 3 | Jumper for setting the video format: PAL/NTSC |
| 4 | Adjust the camera view area |

4.2.1 Analog camera connected with terminal 1

All the cameras with the video output of 1Vp-p 75Ω ,CVBS (composite video broadcast signal) can be connected with the camera module.

Generally, the transmission distance from the analog camera to the outdoor station can reach up to 50 meters by coax cables or about 10 meters by other types of cables.

Two types of connections:

Option 1: The analog camera is powered on all the time

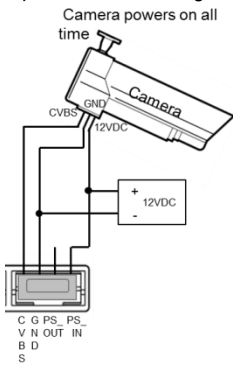

Option 2: The analog camera is powered on only during working hours

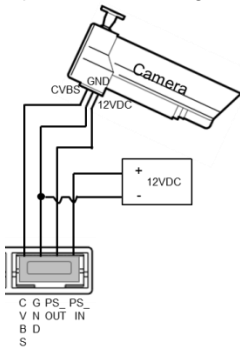

4.2.2 Detached camera connection

Camera module can be used as a detached camera. Wiring is shown below.

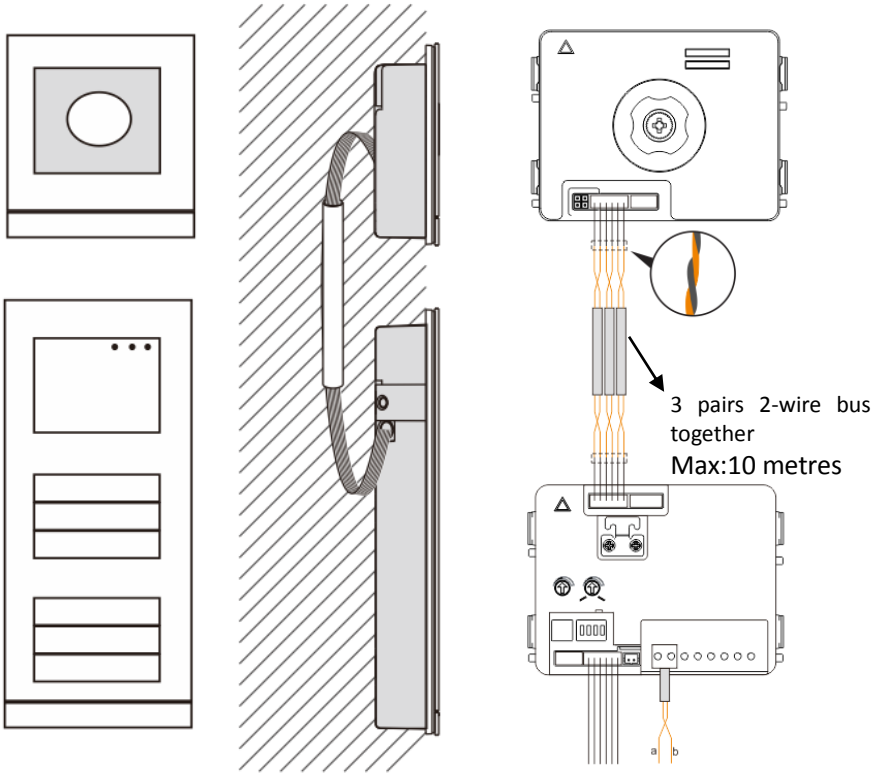

4.3 Round pushbutton module

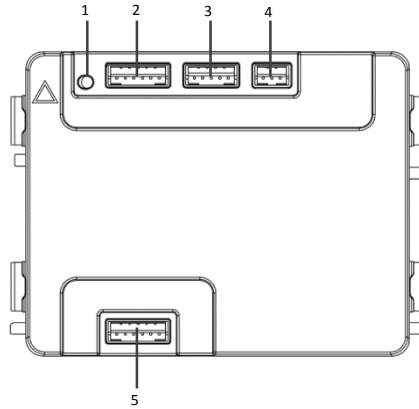

| No. | Functions |
|-----|--|
| 1 | Program button |
| 2 | Connector for previous module |
| 3 | Connector for device software update |
| 4 | Connector for Wiegand output Default format is 26 bits, it can also be extended to 34 bits. |
| 5 | Connector for next module |

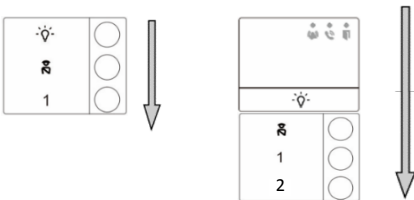

| No. | Functions |
|-----|---|
| 1 | Regardless of the structure of the pushbutton module, button numbers are listed from top to bottom. |
| 2 | Lighting switch/call guard unit function is always assigned to the 1st/2nd button, which is set by audio module. |
| 3 | User names can be printed by using the labelling tool of the ABB-Welcome configuration software. |
| 4 | The round pushbutton module with NFC/IC card reader supports the NFC/IC card. A mobile phone with NFC function is acceptable. ("Door Open" APP required.) |

4.4 Pushbutton module

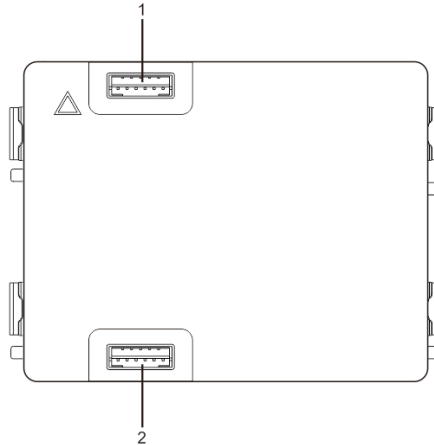

| No. | Functions |
|-----|-------------------------------|
| 1 | Connector for previous module |
| 2 | Connector for next module |

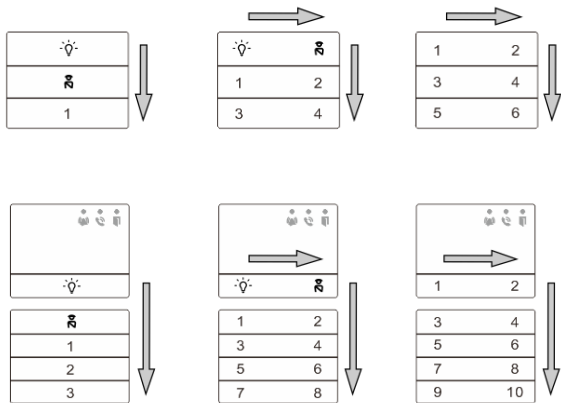

| No. | Functions |
|-----|--|
| 1 | Regardless of the structure of the pushbutton module, the button numbers are listed from top to bottom and from left to right (in the double column mode.) |

| | |
|---|--|
| 2 | Lighting switch/call guard unit function is always assigned to the 1st/2nd button. |
| 3 | User names can be printed by the using the labelling tool of the ABB-Welcome configuration software. |



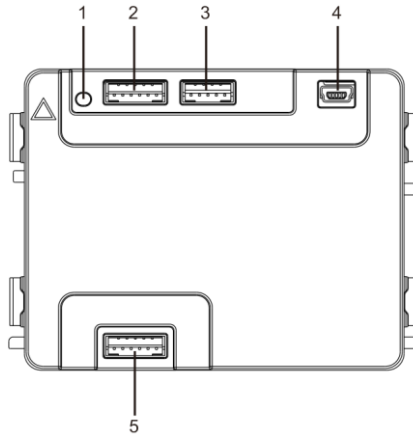









4.5 Keypad module



| No. | Functions |
|-----|--|
| 1 | Program button |
| 2 | Connector for previous module |
| 3 | Connector for device software update |
| 4 | USB connector for connection to the PC: Download/upload the configuration. |
| 5 | Connector for next module |

| | | | |
|--------|-------|--------|---|
| 1 | 2 abc | 3 def | ^ |
| 4 ghi | 5 jkl | 6 mno | v |
| 7 pqrs | 8 tuv | 9 wxyz | ☎ |
| * ← | 0 | # ↵ | 🔊 |

| | | | |
|-----|-----|-----|-----|
| 1 A | 2 B | 3 C | ^ D |
| 4 E | 5 F | 6 G | v H |
| 7 I | 8 J | 9 K | ☎ |
| * ← | 0 L | # ↵ | 🔊 |

| No. | Functions |
|-----|--|
| 1 | <p>Call resident</p> <p>A visitor inputs an indoor station number (001) or apartment number (e.g. 0101, programmed in advance) to call a resident.</p> <p>*Also, the visitor can select a resident name with the button  or the button  of the accompanying display module to make a call.</p> <p>Meanwhile, pressing the button  can cancel the call.</p> <p><i>*This function is only available in Fig. 1.</i></p> |
| 2 | <p>Calling the guard unit</p> <p>A visitor can call a guard unit by pressing the button  if the guard unit is available in the system.</p> |
| 3 | <p>Unlocking by password</p> <p>Press "  + password+  "to release the default lock to the audio module.</p> <p>Press "  +2 +  + password +  " to release the 2nd lock connected to the audio module.</p> <p>The initial password is 123456. Residents can set their own customized password with indoor stations.</p> |
| 4 | <p>System engineering configuration</p> <p>Press "  +  + system password +  " to enter the system engineering configuration menu.</p> <p>The initial system password is 345678, and it can be modified by the administrator.</p> |

4.6 Display and card reader module

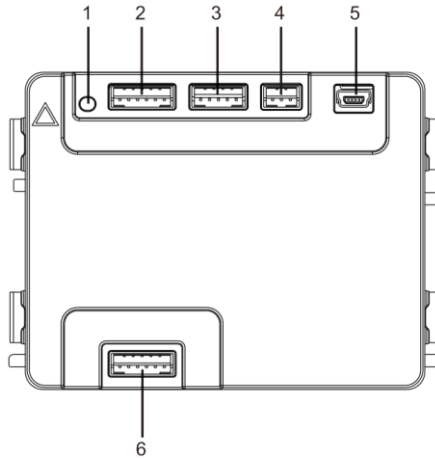

| No. | Functions |
|-----|--|
| 1 | Program button |
| 2 | Connector for previous module |
| 3 | Connector for device software update |
| 4 | Connector for Wiegand output |
| 5 | USB connector for connecting to the PC: Download/upload the Configuration. |
| 6 | Connector for the next module |



| No. | Functions |
|-----|-----------|
|-----|-----------|

| | |
|---|--|
| 1 | LCD display |
| 2 | <p>Supports ID or IC card.</p> <p>Swipe the registered card to release the door lock. The card can be programmed through the module itself, or by using a PC to download the program file. (M251021CR is accompanied with an ID card reader, while the M251022CR is accompanied with an IC card reader.)</p> |
| 3 | <p>Support Wiegand output.</p> <p>The default Wiegand format is 26 bits, but it can also be extended to 34 bits.</p> |

*The display module must be connected after audio module.

Technical specification

M251021CR: Display module with ID card reader

| | |
|----------------|---|
| Work frequency | 125KHz |
| Standard | ISO18000-2 |
| Support card | EM4100, EM4205, EM4305, EM4450, TK4100, T5567 |
| Output format | Wiegand 26, 34 bit |

M251022CR: Display module with IC card reader

| | |
|----------------|--------------------------|
| Work frequency | 13.56MHz |
| Standard | ISO 14443A |
| Support card | Mifare One S50/S70, etc. |
| Output format | Wiegand 26, 34 bit |

4.7 Nameplate module

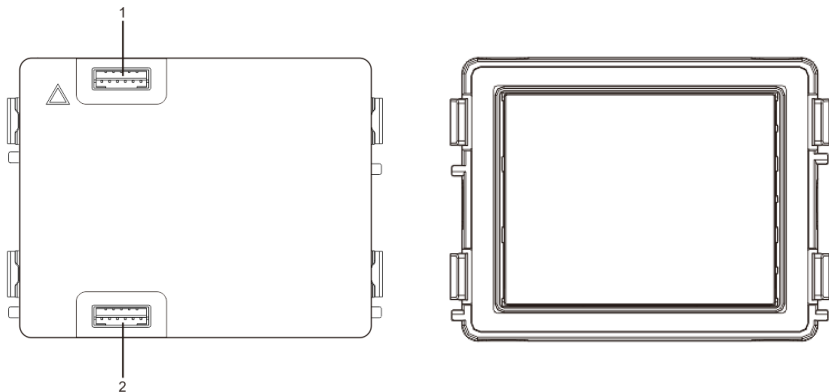

| No. | Functions |
|-----|-----------|
|-----|-----------|

| | |
|---|-------------------------------|
| 1 | Connector for previous module |
| 2 | Connector for next module |

Labeling of the nameplate module can be printed by using the labelling tool of the ABB-Welcome configuration software.

5 Operation

5.1 Pushbutton outdoor station

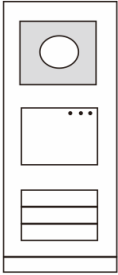

5.1.1 Addressing

1. Configure functions of the 1st/2nd pushbutton

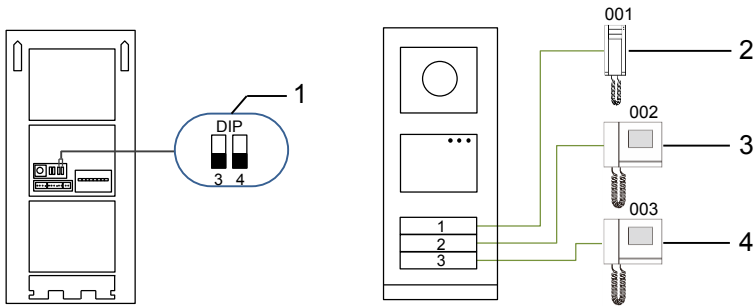

| No. | Functions |
|-----|-------------------|
| 1 | 3->OFF, 4->OFF |
| 2 | Call apartment 01 |
| 3 | Call apartment 02 |
| 4 | Call apartment 03 |

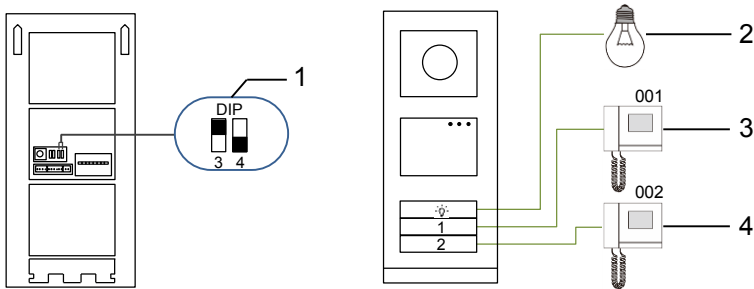

| No. | Functions |
|-----|---|
| 1 | 3-> ON, 4->OFF |
| 2 | Switch on light. The light is connected with a switch actuator. The address of the switch actuator must be the same as the address of this outdoor station. |
| 3 | Call apartment 01 |
| 4 | Call apartment 02 |

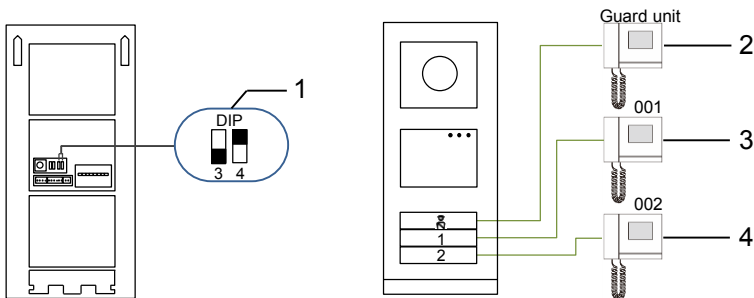

| No. | Functions |
|-----|---|
| 1 | 3-> OFF, 4-> ON |
| 2 | Call the guard unit. If there are multiple guard units in the same section, all guard units will ring at the same time when a visitor presses the button "call guard unit." |
| 3 | Call apartment 01 |
| 4 | Call apartment 02 |

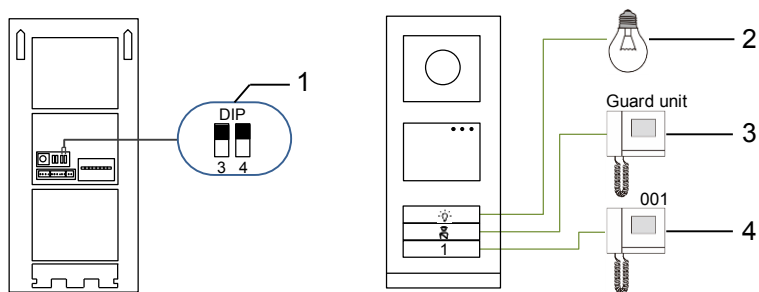

| No. | Functions |
|-----|-------------------|
| 1 | 3-> ON, 4-> ON |
| 2 | Switch on lights |
| 3 | Call guard unit |
| 4 | Call apartment 01 |

2. Configure pushbutton in single or double column modes

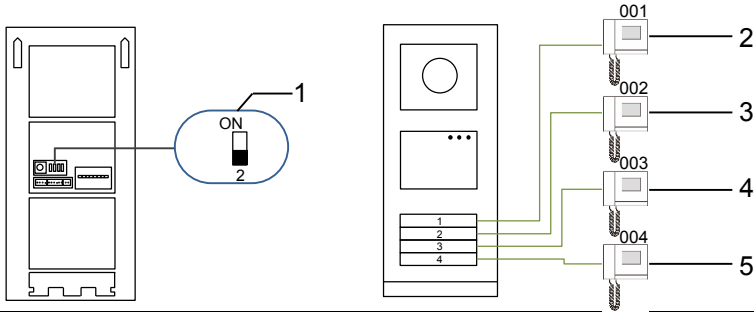

| No. | Functions |
|-----|-------------------|
| 1 | 2-> OFF |
| 2 | Call apartment 01 |
| 3 | Call apartment 02 |
| 4 | Call apartment 03 |
| 5 | Call apartment 04 |

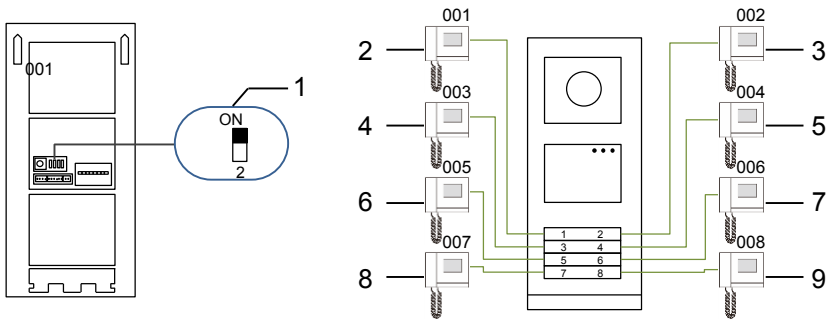

| No. | Functions |
|-----|-------------------|
| 1 | 2-> ON |
| 2 | Call apartment 01 |
| 3 | Call apartment 02 |
| 4 | Call apartment 03 |
| 5 | Call apartment 04 |
| 6 | Call apartment 05 |
| 7 | Call apartment 06 |

| | |
|---|-------------------|
| 8 | Call apartment 07 |
| 9 | Call apartment 08 |

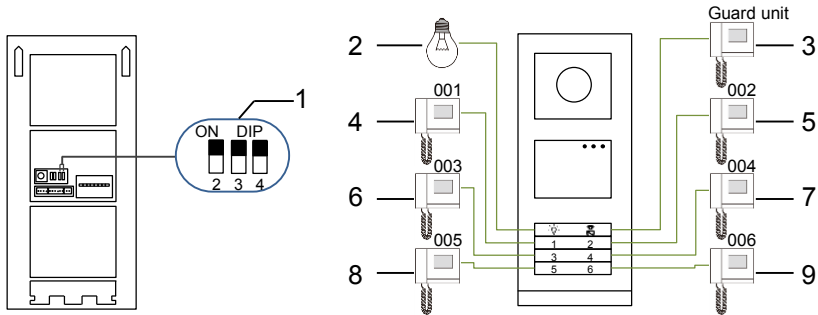

| No. | Functions |
|-----|-----------------------|
| 1 | 2-> ON,3-> ON, 4-> ON |
| 2 | Switch on lights |
| 3 | Call the guard unit |
| 4 | Call apartment 01 |
| 5 | Call apartment 02 |
| 6 | Call apartment 03 |
| 7 | Call apartment 04 |
| 8 | Call apartment 05 |
| 9 | Call apartment 06 |

5.1.2 Setting the language for the voice messages (if the audio module has a speech synthesis function)

If the audio module with a speech synthesis function (M251024A-), the local language can be set.

Set outdoor station address as “0” and hold the 1st button for 3s to play the voice message.

Click on this button to select the language. After choosing the language, hold this button to save and exit the setting.

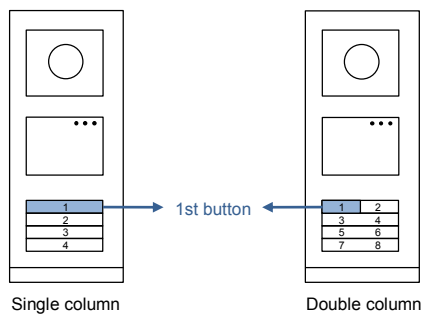

Pushbutton outdoor station used as gate station

If pushbutton outdoor station is set as a gate station, the gateway as an important system device must be used and it must be set as floor gateway mode.

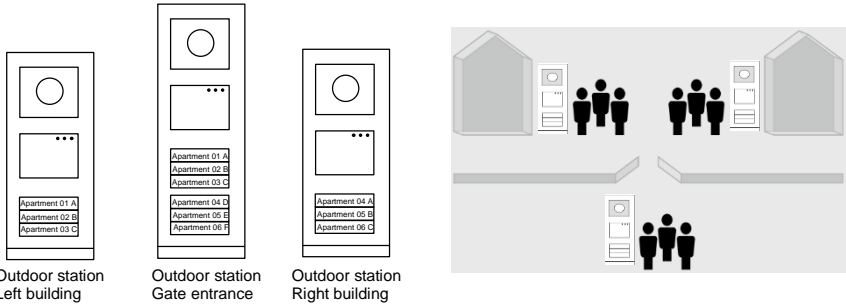

For detailed information, please refer to the Gateway User Manual, floor gateway chapter.

5.2 Pushbutton outdoor station with display module

The display and card reader module can be assembled with a pushbutton outdoor station. The user can swipe cards to open the door. For this combination, a master card is needed for an electrician to manage this outdoor station.

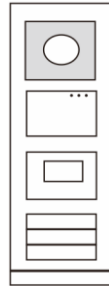

Register a master card/deactivate master card. (We recommend that this work is carried out by specialized personnel.)

1. Disconnect the power supply.
2. Reconnect the power
3. Hold the “program button” for 5s to enter “program master card” interface within 30s.
4. Any card swiped by the reader during this time will be taken to be the new MASTER card. A prompt “Register master card successfully” will appear on the screen.

If the card exists, when you swipe it again, the information will be deleted, and a prompt “Delete master card successfully” will appear on the screen.

Only 1 master card can be registered.

Enter system setting using master card:

1. Swipe the MASTER card to enter the setting menu. Three LEDs will turn on.
2. 6 options:
 - Program card
 - Language
 - Wiegand output
 - Choose door
 - Date and time
 - Back

There is a 5s countdown for each option.
3. Swipe the MASTER card again within 5s to change to the next option. Or, 5s over, the current option will be chosen.

4. 30s over, to exit the settings menu.

Swipe the MASTER card

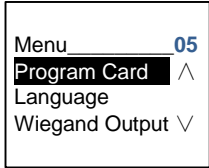

5s over, choose current option

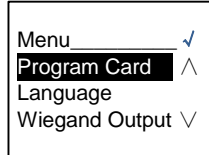

Swipe the MASTER card, enter the setting

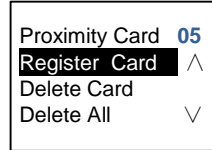

Swipe the MASTER card within 5s to move to next option.

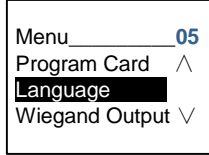

Swipe the MASTER card within 5s to move to next option.

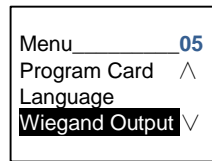

5.3 Pushbutton outdoor station with keypad module

The keypad module can be assembled with a pushbutton outdoor station and users can enter the password to open the door.

Users can enter the system settings menu by using the following steps. (Press # to confirm and * to cancel. The default system password is 345678.)

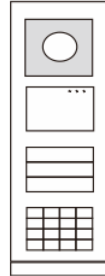

1. Set the device as an outdoor station or a gate station.

Outdoor station:

#* system password # =>

1 # => 1 #

Gate Station:

#* system password # =>

1 # => 2 #

2. Modify "system password"

#* system password # =>

2 # => Enter new password (6-8 bits) # => Enter the password again #

3. Modify "door open code"

#* system password # =>

3# => Enter new door open code (3-8 bits) # => Enter the code again #

4. Set the voice message

If the audio module with the speech synthesis function (M251024A-) is assembled, the local language can be set.

#* system password # =>

4# => Press or to choose the language => #

5. Enable/disable access control function

Enable access control function:

#* system password # =>

5# => 1 #

Disable access control function:

#* system password # =>

5# => 2 #

***Reset the system password of keypad module:**

It is possible to reset the system password to the factory setting if you have forgotten it. The restoration of default factory settings does not delete the rest of the information programmed on the system, such as user names and other settings.

1. Disconnect the power supply.
2. Reconnect the power.
3. Hold the “program button” for 5s within 30s.
4. A “di” will sound and the system password will be reset to the default (345678).

5.4 Round pushbutton outdoor station with IC/NFC

Enroll the cards

For round pushbutton module with NFC/IC card reader, cards can be enrolled or deleted. A maximum of 500 cards can be supported.

Programming

| Function | Command | LED |
|-------------------|---------------------|--------|
| Create admin card | Swipe card 1x | Green |
| Enter settings | Swipe admin card 1x | Orange |

The system will take the first card swiped after powering up the system within 60s to be the admin card.

After entering settings, the following functionalities can be implemented:

| Function | Command | LED |
|------------------|---------------------------|----------------------|
| Enroll user | Swipe admin card 1x | Orange flash 1x |
| | Swipe card (new user) 1x | Green |
| Delete user | Swipe admin card 2x | Orange flash 2x |
| | Swipe card (user x) 1x | Green |
| Enroll new admin | Swipe admin card 3x | Orange flash 3x |
| | Swipe card (new admin) 1x | Green |
| Delete admin | Swipe admin card 4x | Orange flash 4x |
| | Swipe card (admin x) 1x | Green |
| Delete all users | Swipe admin card 5x | Orange flash quickly |
| | Swipe admin card 1x | Green |

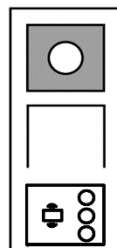

During setting, please swipe the same admin card.

| Function | Command | LED |
|---------------|--|-----|
| Exit settings | Swipe admin card 1x or no cards swiped within 15 seconds | -- |

Open a door

| Function | Command | LED |
|-------------|--|-------|
| Open a door | Swipe the enrolled keycard or mobile phone with "Door Open" App installed. | Green |

Reset to factory default

| Function | Command | LED |
|--------------------------|--|--|
| Reset to factory default | Disconnect the power supply. Reconnect the power supply. Long-press the “program” button for 5s within 60s. Finish reset. | — White Red, green, orange cycle — |

Technical specifications for round pushbutton module with IC/NFC:

| | |
|---------------------|---|
| Work frequency | 13.56MHz |
| Standard | ISO 14443A |
| Support card | Mifare One S50/S70, etc. |
| Output format | Wiegand 26, 34 bit |
| Support NFC devices | Mostly NFC mobile. (Not all devices; it needs test before using this function.) |

Set the Wiegand format

- 1. Swipe admin card to enter system setting. (Orange LED is on.)
- 2. Short press 1st button to change the Wiegand format to 26 bit or 34 bit. (Default is 26 bit.)
The different format is indicated by the LED and sound feedback.



Switch off validation

In some case, the users only register cards as a third party and not on outdoor station. When the users swipe these cards at the outdoor station the door will be opened, but a warning indication will be displayed on display module. It is not necessary to play this warning. Therefore, validation needs to be switched off so that wrong indication on display module will not appear, even though the card is not enrolled at this outdoor station.

- 1. Swipe admin card to enter system setting. (Orange LED is on.)
- 2. Long press 1st button for 3s to switch validation on/off. (Default validation is “on.”)
The status on/off is indicated by the LED and sound feedback.



Use app to open door

Round pushbutton module with NFC can be used for opening doors. Programming is carried out directly on the module or via a web browser (requires IP gateway 83342-500). Additional devices are not required for commissioning.

To the play store

https://play.google.com/store/apps/details?id=com.abb.allegro3_nfcdooropener&hl=en

1. Download and install the ABB door opener app from Google Play Store.
2. Turn on the NFC function of your device.
3. Enter setting mode of your round pushbutton module.
4. Start the app at your device.
5. Set up your device as new user.
6. Configure your personal settings.

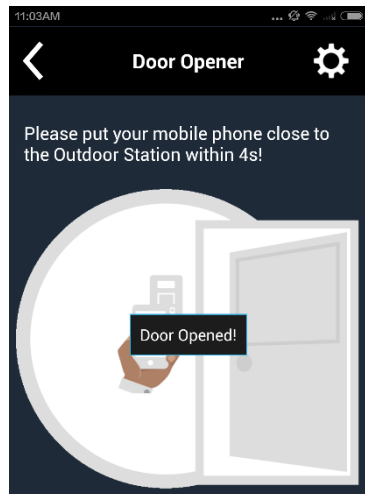
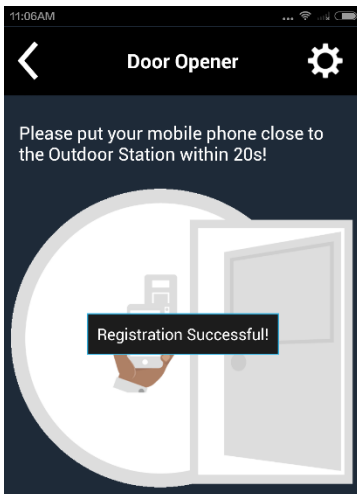
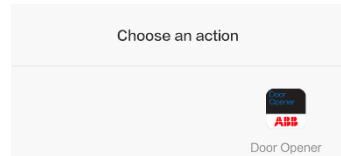
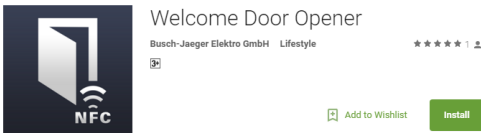

5.5 Keypad outdoor station

5.5.1 Call a resident (3 types)

1. Physical address

The physical address is the internal code that the outdoor station will send through the bus connection to indoor stations or other devices in the system. For each apartment, physical address means the address of an indoor station that is installed in the apartment.

For each building, physical address means the address of a gateway that is installed for each building. It is also called the building number.

In standby mode, a visitor can press the physical address corresponding to the residence (from 001 to 250).

For a complex building, a visitor needs to press the building number (01- 60) plus the physical address (001 - 250), or make a call in the gate station.

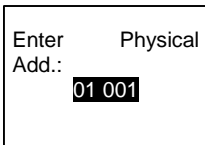
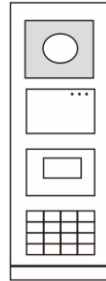

2. Logic address

Logic address is a code that a visitor can press to make a call. The code must be assigned first and then associated with the physical address.

The apartment number or some special codes can be used to set the logic address, which is easy for the users to remember.

Set the logic address by following these steps:

Assign the logic address:

#* system password # => system setting =>

Contact => Add => Logic Add.

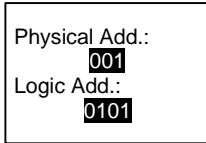



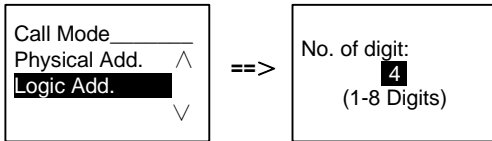

Turn on the “Logic address” call mode
#* system password # => system setting =>
Configurations => Call Mode



3. Resident name

(Note: This function is only available for the outdoor station with a keypad module (M251021K-.))

In standby mode, press the button  or the button  to display resident names. Use the buttons  and  to search for the desired residential station and press the button  to make a call.

Also, a visitor can enter the resident name using the keypad to make a call.

Resident names must be assigned first and then associated with the physical address.

#* system password # => system setting

=> Contact => Add => User Names

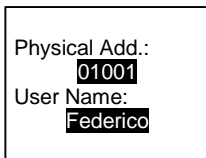

5.5.2 Call the guard unit

Press the button  to make a call to a guard unit.

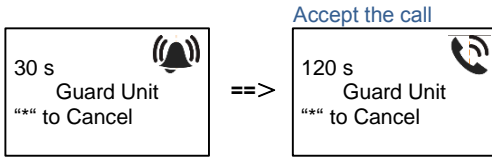

5.5.3 If an indoor station is in "leave home mode"

If an indoor station works in the "leave home mode," a visitor can record a message for the resident after entering the following interface.

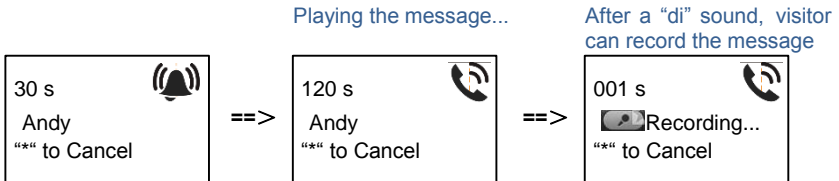

5.5.4 If a guard unit is in "intercept mode"

If a guard unit works in the "intercept mode," the call from an outdoor station to an indoor station will be intercepted by the guard unit and after the identity is confirmed, the guard unit will forward the call to the indoor station.

Call from an outdoor station to an indoor station

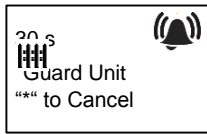

Guard unit accepts the call

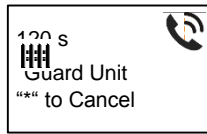

Guard unit transfers the call to an indoor station

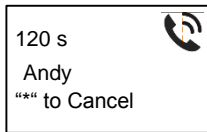
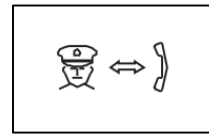

5.5.5 System settings

(In settings, press “#” to confirm and “*” to cancel. The default system password is 345678.)

1. Enter the system settings menu
#* system password #

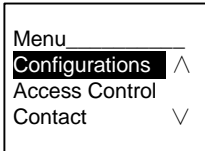

2. Configurations
 - (1) Set the device as an outdoor station or a gate station.

Outdoor station:

#* system password # =>

Configurations # => Device Type # => Outdoor St. # (Default)

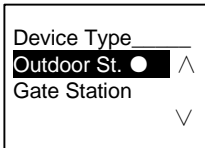

Gate station:

#* system password # =>

Configurations # => Device Type # => Gate station #

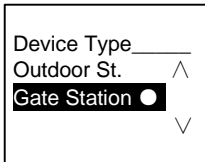

- (2) Set the call mode: Make a call by a physical address or a logic code.

Set the call mode by Physical Address:

#* system password # =>

Configurations # => Call mode # => Physical Address #

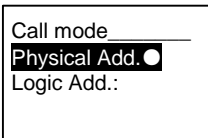

Set the call mode by a Logic Code (1-8 digits).

#* system password # =>

Configurations # => Call mode # => Logic Code #

| | |
|---------------|---|
| Call Mode | |
| Physical Add. | ^ |
| Logic Add.: | ● |
| | v |

(3) System password setting

Modify the system password

#* system password # =>

Configurations # => System code # => Modify #



Reset the system password

#* system password # =>

Configurations # => System code # => Reset #

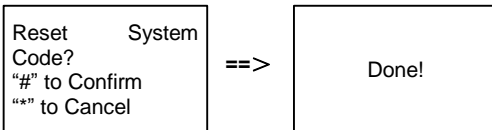

3. Access control

(1) Door open code

The password can be set using 3-8 digits. The default door open password is "123456" and it can be changed at an outdoor station.

Users can set their own passwords at the indoor stations. A total of 6,000 passwords can be stored.

Set the door open password ON/OFF (default: 123456)

#* system password # =>

Access Control # => Door open code # => Enable/disable #

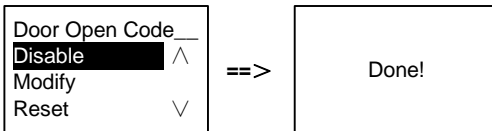

Modify the door open password

#* system password # =>

Access control # => Door open code # => Modify #



Reset the door open password

#* system password # =>

Access control # => Door open code # => Reset #

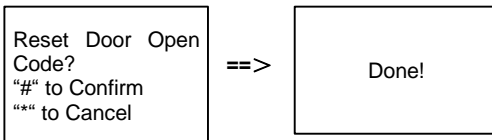

(2) Proximity card (3,000 cards can be registered for outdoor station.)

Register cards:

#* system password # =>

Access control # => Proximity card # => Register card #

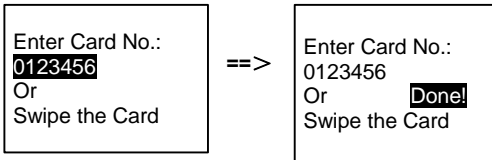

Delete cards:

#* system password # =>

Access control # => Proximity card # => Delete card #

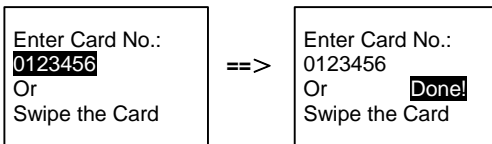

Delete all cards

#* system password # =>

Contact # => Proximity card # => Delete All #

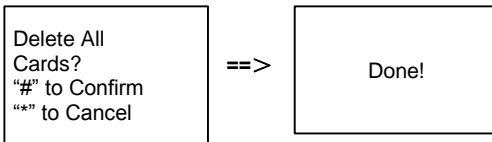

4. Contact (3,000 names using a combination of 24 alphanumeric characters)

(1) Add

Add the contact by user names

#* system password # =>

Contact # => Add # => User Names #

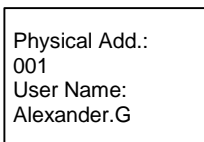

Resident names must be associated with a physical address.

Add the contact by logic address

#* system password # =>
 Contact # => Add # => Logic add. #

| |
|--|
| Physical Add.: 001 Logic Add.: 0101 |
|--|

Logic address must be associated with a physical address.

(2) Modify

Modify contact by user names

#* system password # =>
 Contact # => Modify # => User Names #

| |
|---------------|
| Alexander.G ^ |
| Bodin.K |
| Christian.G v |

Modify the resident names with the corresponding physical address.

Modify contact by logic address

#* system password # =>
 Contact # => Modify # => Logic add. #

| |
|------------------------------|
| Enter Logic Add.: 0101 |
|------------------------------|

Modify the logic address and its corresponding physical address using the alphanumeric keypad.

(3) Delete

Delete the contact by user names

#* system password # =>
 Contact # => Delete # => User Names #

| | |
|-------------|---|
| Alexander.G | ^ |
| Bodin.K | |
| Christian.G | v |

Delete the contact by logic address

#* system password # =>

Contact # => Delete # => Logic add. #

| |
|------------------------------|
| Enter Logic Add.: 0101 |
|------------------------------|

(4) Clear all

#* system password # =>

Contact # => Clear all #

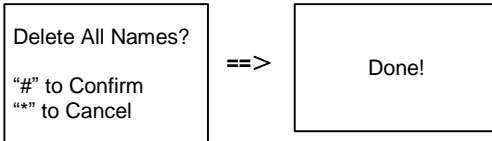

Clear all lists including resident names and logic address entries from this menu.

5. System setting

(1) Date and time

#* system password # =>

Settings # => Date & time # => Enter time and date => #

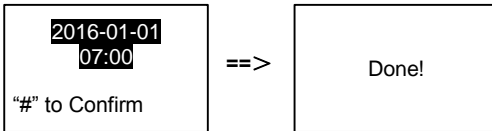

(2) Door open time for 2nd lock

#* system password # =>

Settings # => Door Open Time # => Time 1-10s (default: 3s) => #

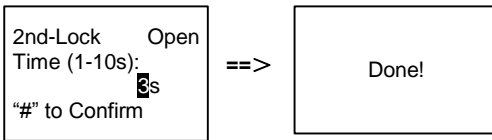

(3) Setting the voice message on/off

If the audio module with the speech synthesis function (M251024A-.) is assembled, the speech synthesis function can be enabled or disabled. Meanwhile, the local language can be chosen, too.

#* system password # =>

Settings # => Voice message #

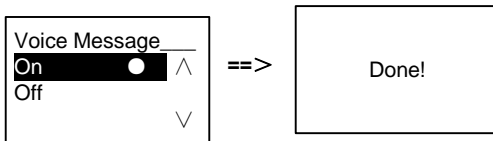

If the audio module does not have a speech synthesis function, this will be indicated when user enters the menu.

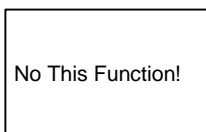

(4) Select language

#* system password # =>
Settings # => Language #

| | |
|----------|-----|
| Language | |
| English | ● ^ |
| Français | |
| Italiano | ∨ |

(5) Welcome Msg.

#* system password # =>
Settings # => Welcome Msg. #

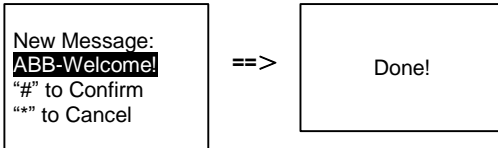

A total of 64 characters can be entered.

(6) Setting the Wiegand output digits

#* system password # =>
Settings # => Wiegand Output #

| | |
|----------------|-----|
| Wiegand Output | |
| 26 bit ! | ● ^ |
| 34 bit ! | |
| | ∨ |

(7) Set the related door lock when swiping the card

#* system password # =>
Settings # => Choose Door #

| | |
|-------------|-----|
| Choose Door | |
| 1st-Lock | ● ^ |
| 2nd-Lock | |
| | ∨ |

Setting the lock that will be released when swiping the registered card:

(8) Reset

#* system password # =>
Settings # => Reset # => #

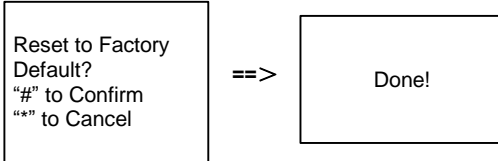

Reset all settings to factory settings, but other information, e.g. user names, logic addresses and card information cannot be reset.

(9) Information

#* system password # =>
Settings # => Information #

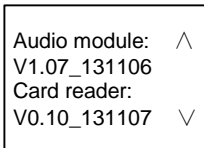

View the software information of each modules of the outdoor station.

***Reset the system password of keypad module:**

It is possible to reset the system password to factory settings if you have forgotten it. The restoration of default factory settings does not delete the other information programmed on the system, such as user names and other settings.

1. Disconnect the power supply.
2. Reconnect the power
3. Hold the “program button” for 5s within 30s.
4. A “di” will be sounded and the system password will be reset to the default (345678).

5.6 Keypad outdoor station without display (camera + audio + keypad)

5.6.1 Calling a resident by inputting physical address

In standby mode, a visitor can enter the physical address corresponding to the residence to call directly, from 001 to 250.

For a complex building, the visitor needs to press the building number (01-60) plus physical address (001-250) to make a call from a gate station.

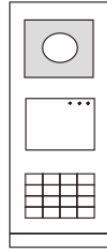

5.6.2 Call guard unit

Press the button  to make a call to a guard unit.

5.6.3 System settings

Users can enter the system settings by following these steps. (In settings, press “#” to confirm, press “*” to cancel. The default system password is 345678.)

1. Set the device as an outdoor station or a gate station.

Outdoor station:

#* system password # =>

1 # => 1 #

Gate station:

#* system password # =>

1 # => 2 #

2. Modify the "system password"

#* system password # =>

2 # => Enter new password (6-8 bits) # => Enter the password again #

3. Modify the "door open code"

#* system password # =>

3 # => Enter new door open code (3-8 bits) # => Enter the code again #

4. Setting the voice message

If the audio module with the speech synthesis function (M251024A-) is assembled, the local language can be set.

#* system password # =>

4# => Press or to choose the language => #

5. Enable/disable the access control function

Enable access control function:

#* system password # =>

5# => 1 #

Disable access control function:

#* system password # =>

5# => 2 #

***Reset the system password of keypad module:**

It is possible to reset the system password to the factory setting if you have forgotten it. The restoration of default factory settings does not delete the other information programmed on the system, such as user names and other settings.

1. Disconnect the power supply.
2. Reconnect the power.
3. Hold the "program button" for 5s within 30s.
4. A "di" will be sounded and the system password will be reset to the default (345678).

6 Advanced configuration

Connect to the PC to configure the keypad or display

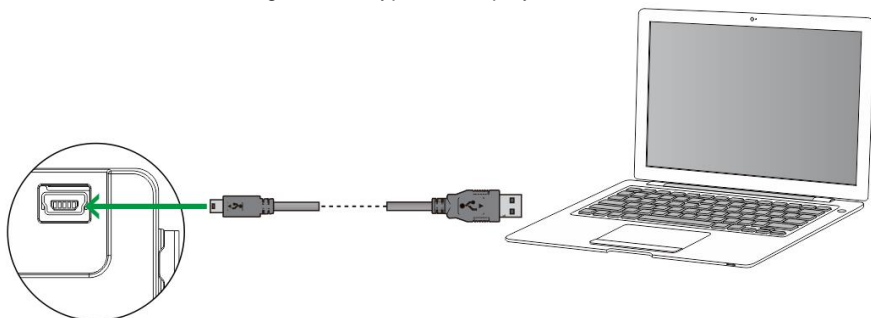

7 Technical data

| Designation | Value |
|--|---|
| Operating temperature | -40 °C - +70 °C |
| Protection (cover frame assembled) | IP 54 |
| Power supply, door opener (Lock-GND) | 18V 4A impulsive, 250 mA holding |
| Floating output, door opener (COM-NC-NO) | 30 V AC / DC 1A |
| Single-wire clamps | 2 x 0.28 mm ² - 2 x 0.75 mm ² |
| Fine-wire clamps | 2 x 0.28 mm ² - 2 x 0.75 mm ² |
| Bus voltage | 20-30 V |

8 Mounting/installation



Warning

Electric voltage!

Dangerous currents flow through the body when coming into direct or indirect contact with live components.

This can result in electric shock, burns or even death.

- Disconnect the mains power supply prior to installation and/or disassembly!
- Permit work on the 110-240 V supply system to be performed only by specialist staff!

8.1 Requirements for the electrician



Warning

Electric voltage!

Install the device only if you have the necessary electrical engineering knowledge and experience.

- Incorrect installation endangers your life and that of the user of the electrical system.
- Incorrect installation can cause serious damage to property, e.g., fire.

The minimum necessary expert knowledge and requirements for the installation is as follows:

- Apply the "five safety rules" (DIN VDE 0105, EN 50110):
 1. Disconnect from power source
 2. Secure against being re-connected
 3. Ensure that there is no voltage
 4. Connect to the earth
 5. Cover or barricade adjacent live parts.
- Use suitable personal protective clothing.
- Use only suitable tools and measuring devices.

- Check the type supply network (TN system, IT system, TT system) to secure the following power supply conditions (classic connection to the ground, protective grounding, necessary additional measures, etc.).

8.2 General installation instructions

- Terminate all branches of the wiring system via a connected bus device (e.g., indoor station, outdoor station, system device).
- Do not install the system controller directly next to the bell transformer and other power supplies (to avoid interference).
- Do not install the wires of the system bus together with 100-240 V wires.
- Do not use common cables for the connecting wires of the door openers and wires of the system bus.
- Avoid bridges between different cable types.
- Use only two wires for the system bus in a four-core or multi-core cable.
- When looping, never install the incoming and outgoing bus inside the same cable.
- Never install the internal and external bus inside the same cable.



The following installation situations must be avoided without fail:

- Direct light
- Direct sunlight
- Extremely bright picture background
- Highly reflective walls on the opposite side of the door station
- Lamps or direct light sources

8.3 Mounting

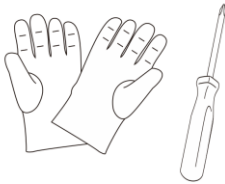

Prepare a pair of gloves to protect yourself from cutting.

Dimension

Audio module

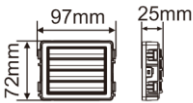

Camera module

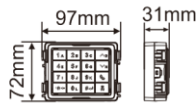

Nameplate module

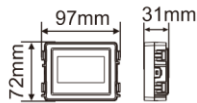

Pushbutton module

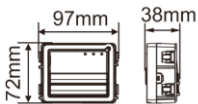

Keypad module

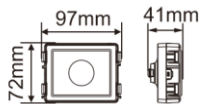

Display and card reader module

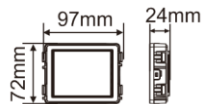

Cover frame

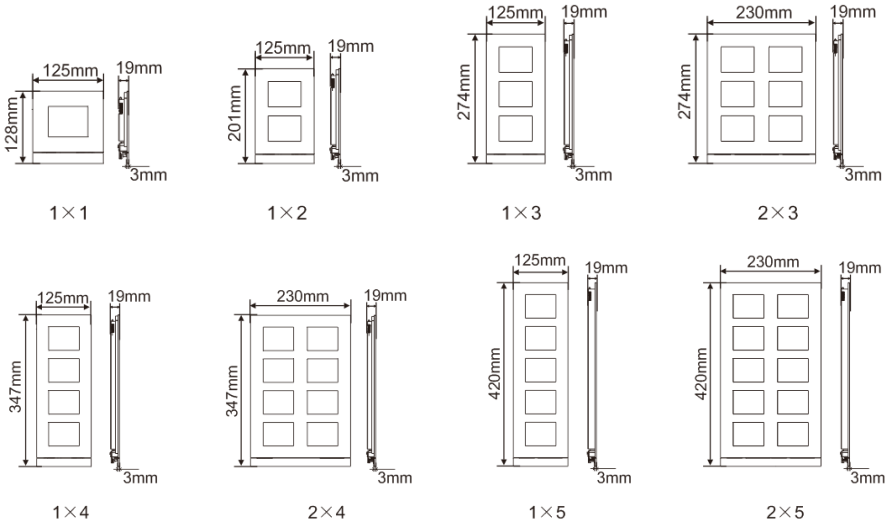

Flush-mounted

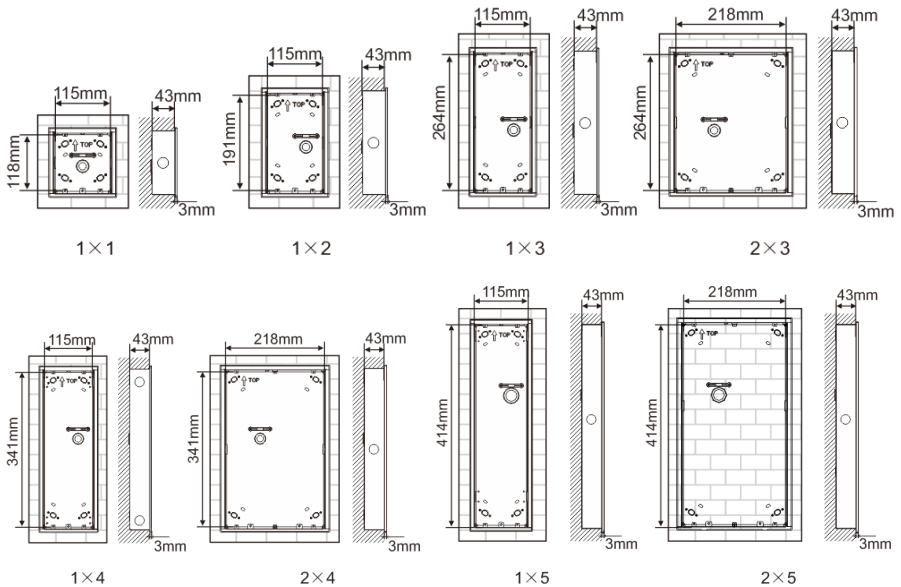

Rain hood

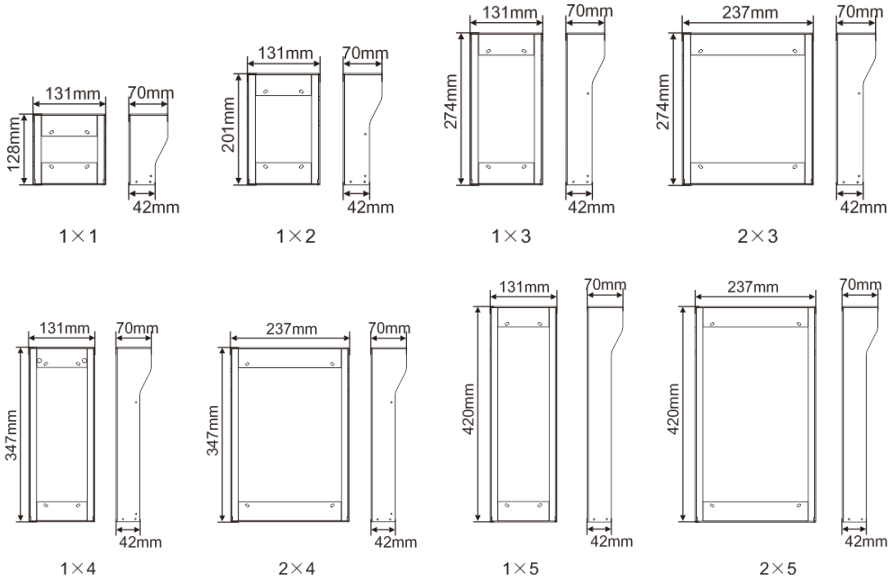

Components of the outdoor station

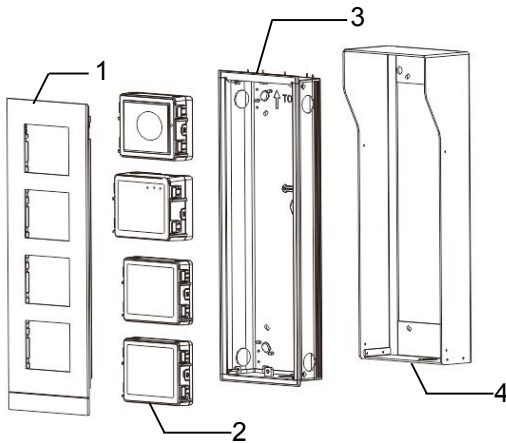

| No. | Functions |
|-----|-------------------|
| 1 | Cover frame |
| 2 | Modules |
| 3 | Flash-mounted box |
| 4 | Rain hood |

Mount each module at the cover frame

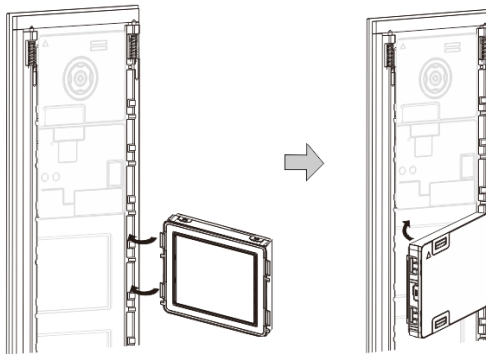

1. Insert each module into the cover frame from behind until it clicks in place. All modules can be inserted, e.g. the camera module, audio module, pushbutton module, keypad module, display and card reader module, nameplate module.
2. Pay special attention to the top to bottom orientation of each module.

Modules wiring

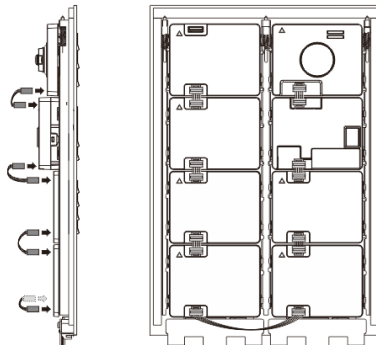

1. Use cables to connect the modules together one by one.
2. Ensure that the audio module is connected next to the camera module.

The distance zones for the installation of the outdoor station

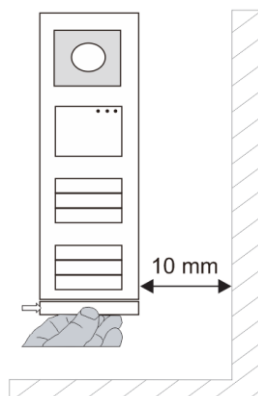

When selecting the installation site, ensure that the minimum distance to the right side is adhered to for the removal of the end strip.

Wires

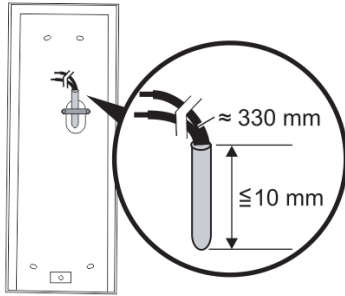

1. Prepare the installation box.
2. Strip the wires.
 - The insulated section of the cable end must not be longer than 10 mm.

Assemble the frame into the flush-mounted box

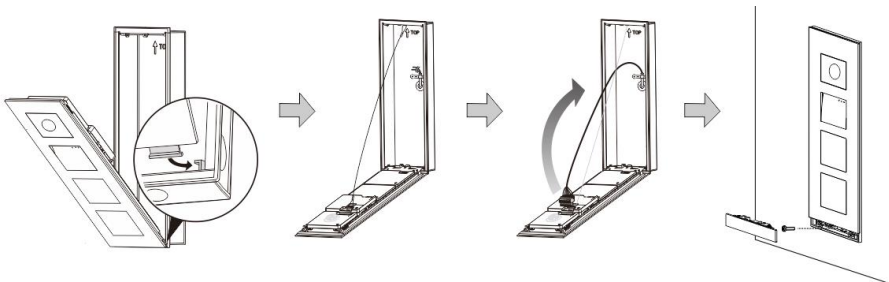

1. Hang the device in the installation box.
2. Fasten the safety loop.
3. Connect the wires into the enclosed clamp and plug the clamp onto the contact pins. Fold the device and shut it until it audibly snaps in.
4. Screw on the front of the device.

Four types of installation

Option 1: Flush-mounted only with a flush-mounted box

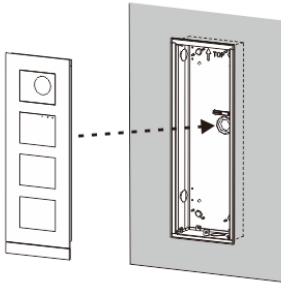

Option 2: Flush-mounted with a rain hood

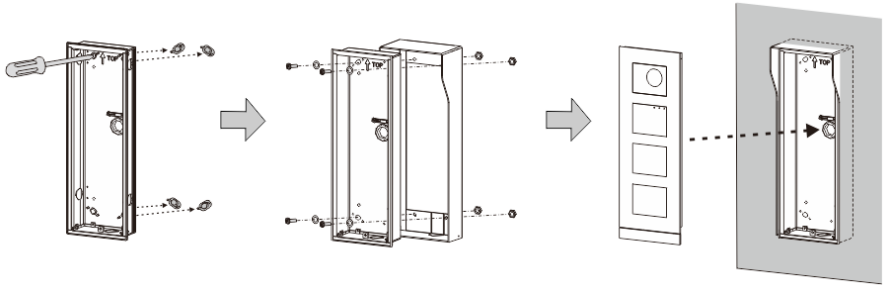

Option 3: Surface-mounted with a rain hood

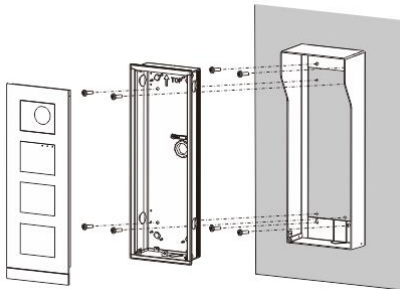

Option 4: Cavity wall installation

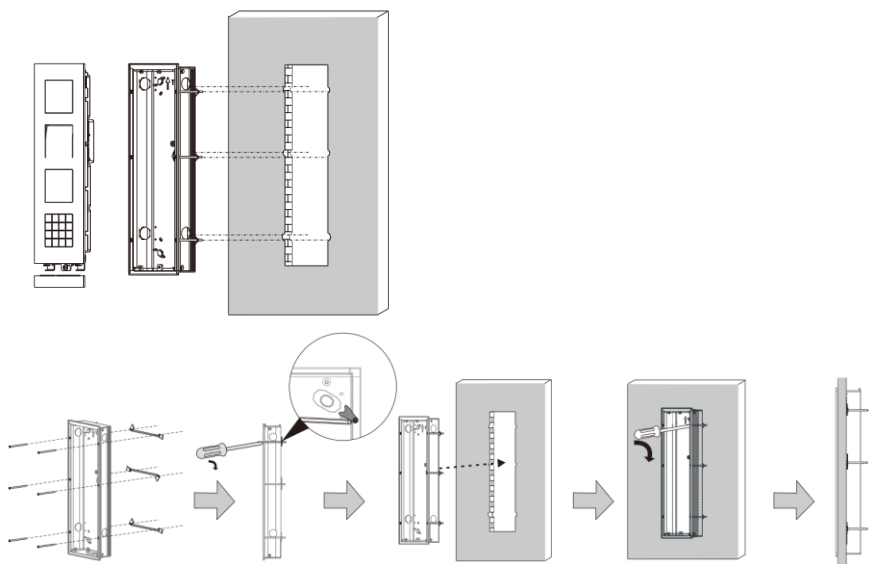

Dismounting outdoor station

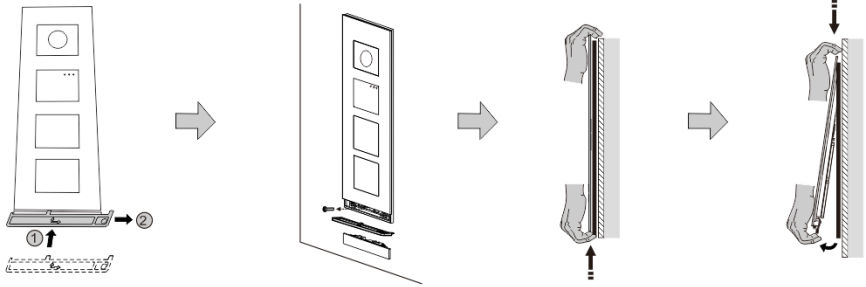

1. Use the enclosed mounting tool to remove the end strip.
2. Remove the screw that is used to affix the cover frame.
3. Push up and pull out the outdoor station on the bottom of the cover frame.

Dismount the modules

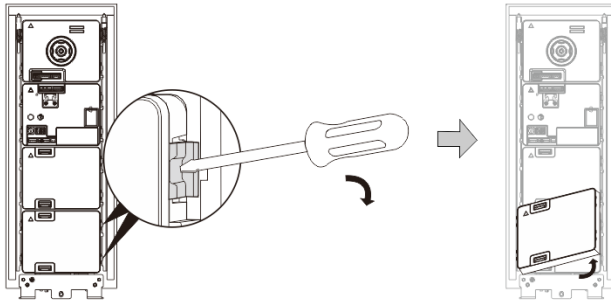

1. Dismount the module from one side of the module.
2. Take out the modules.

Replace the nameplates

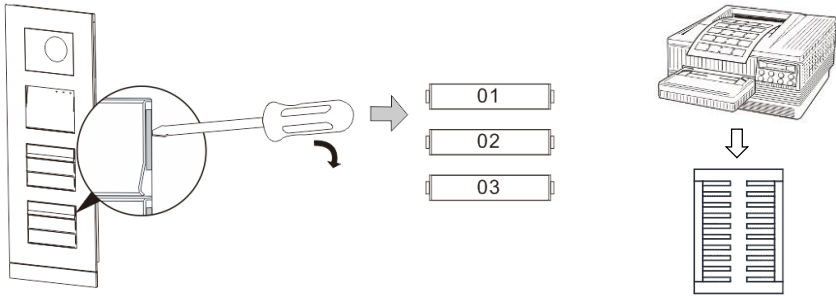

1. Remove the pushbutton cover and write the user names on the label.
2. *Use a labelling sheet with appropriate software to correctly format and print the labels.

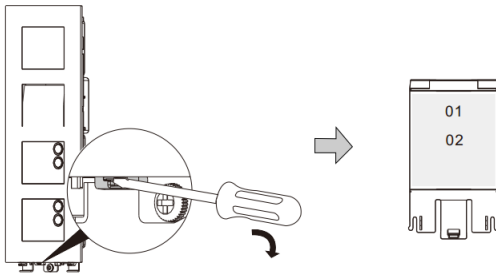

Adjust the angle of the camera

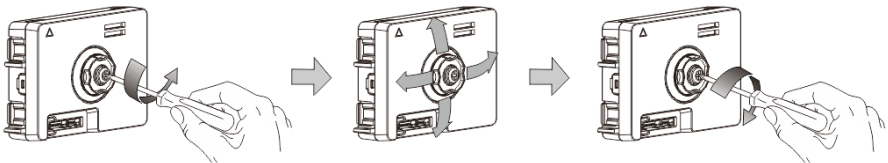
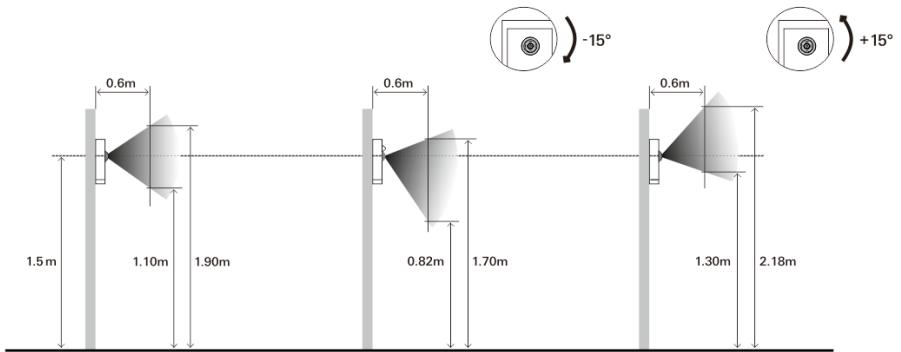
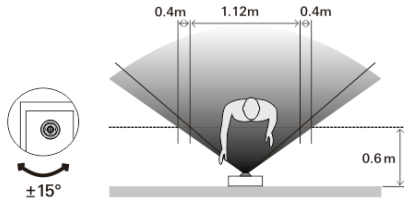

Fig. 1 Adjust the angle of the camera

1. Unscrew the camera.
2. Adjust the angle of the camera in four directions (up, down, right and left).

3. Screw on the camera.



Extension of the outdoor station

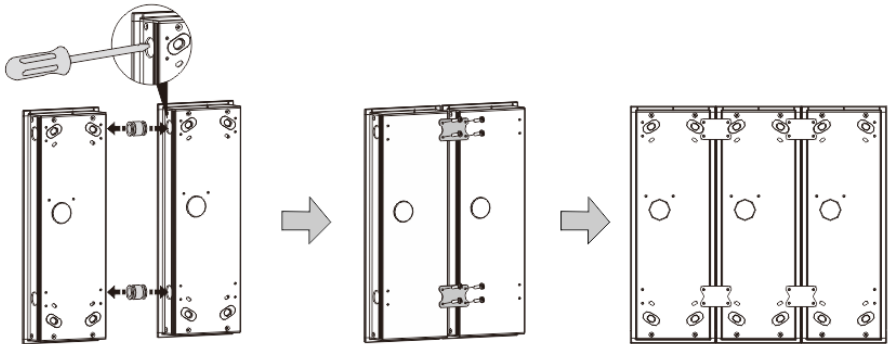
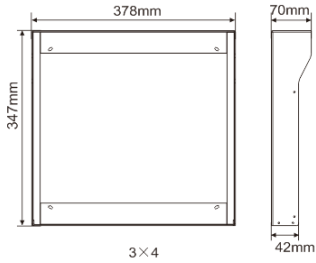

1. Make a hole for the cable.
2. Use the joining fixtures to assemble the flush-mounted boxes horizontally.
3. Run the connection wires between the boxes.

*The extension is useful for multi-outdoor station connections.

Notice

We reserve the right to at all times make technical changes as well as changes to the contents of this document without prior notice.

The detailed specifications agreed to at the time of ordering apply to all orders. ABB accepts no responsibility for possible errors or incompleteness in this document.

We reserve all rights to this document and the topics and illustrations contained therein. The document and its contents, or excerpts thereof, must not be reproduced, transmitted or reused by third parties without prior written consent by ABB.